





FLANGE COUPLINGS

TYPES AND OPERATING DESCRIPTION

Properties of flange couplings

				
Product	BoWex® FLE-PA/-PAC	MONOLASTIC®	BoWex-ELASTIC®	SINULASTIC®
Type	Torsionally stiff flange coupling	Flexible flange coupling	Highly flexible flange coupling	Highly flexible flange coupling
Properties				
Torsionally stiff	●			
Torsionally flexible		●		
Highly flexible			●	●
Damping vibrations		●	●	●
Maintenance-free	●	●	●	●
Axial plug-in	●	●	●	●
Special features / applications				
Variant diversity	very high	high	very high	very high (type A, B, T, V)
Flange dimension	SAE standard and special dimensions	type 3/4 hole, SAE standard and special dimensions	SAE standard and special dimensions	SAE standard and special dimensions
Internal spline	see standard programme of BoWex® hubs	for SAE or DIN pump shafts	see standard programme of BoWex® hubs	Type B
Applications	hydrostatic drives of construction machines, agricultural machines, ...	hydrostatic drives of construction machines, agricultural machines, ...	generators, splitterboxes, water pumps, piston compressors, agricultural machines, gensets, mill drives, separator drives, ...	generators, gensets, splitterboxes, traction drives, hydraulic pumps, piston compressors, ...
Performance data				
Max. rated torque T_{KN} [Nm]	6,600	1,850	70,000	25,000
Max. speed n [rpm]	6,000	6,000	6,200	3,800
Flange (standard and special)				
Material	fibre-glass reinforced polyamide (PA)	natural rubber	natural rubber	natural rubber EPDM
	combination of polyamide with carbon fibre share and steel flange (PAC)			
Elastomer hardness	Torsionally stiff	65, 70 Shore A	various kinds of hardness for vibration adaptation of drives	miscellaneous: S, M, H, U
Flange (standard)				
Temperature range [°C] min./max.	-25 / +130 (PA)	-40 / +100	-40 / +100	-40 / +120
	-25 / +130 (PAC)			
Engine power [kW]				
Max.	800	250	5,000	3,500

- ≈ Standard
- ≈ On request
- * ≈ Depending on size

FLANGE COUPLINGS

TYPES AND OPERATING DESCRIPTION

Product finder of flange couplings

Product	BoWex® FLE-PA/-PAC	MONOLASTIC®	BoWex-ELASTIC®	SINULASTIC®
Type	Torsionally stiff flange coupling	Flexible flange coupling	Highly flexible flange coupling	Highly flexible flange coupling
Geometries				
Design	extremely short	short	short	short
Max. radial displacement	0.5 mm	1 mm	9.5 mm	3 mm
Shaft diameter min./max. [mm]	20 / 125	20 / 60	21 / 275	20 / 240
Types (extract)				
Intermediate shaft types » bridging larger shaft distances	–	–	HE-ZS	Type B and V
Shaft-to-shaft connection		–	HEW1 and HEW2, HEW-ZS	○
Flange-to-shaft connection	Standard	Standard	HE1, HE2, HE3 and HE4, HE-ZS	●
For cardan shafts » connecting couplings for I. C.-engines	–	–	HEG1 and HEG2	○
Combination with pump mounting flange	●	●	●	●
Certifications / type examinations				
ATEX			●	○
Bureau Veritas		●	●	○
DNV/GL			●	○
GOST R / GOST TR		●	●	○

● ≈ Standard

Please note: Pump mounting flanges



For connecting hydraulic pumps to the diesel engine KTR supplies mounting flanges according to SAE connection dimensions sizes SAE 6 to SAE 1. These flanges are made of steel and EN-GJL-250 for hydraulic pumps with flange connections according to SAE-A, -B, -C, -D and -E as types with 2 and 4 holes.

Pump connection housings made of EN-GJL-250 to be mounted directly to the back plate of the engine.

SINULASTIC®

highly flexible flange coupling

Description of product and application

SINULASTIC® is a modularly structured series of highly flexible flange couplings based on a disk-shaped coupling body. Four practical basic versions with individual properties cover a wide range of applications primarily for diesel engine drives, but also general drive tasks.

The main task of the coupling is reducing torsional vibrations resulting from excitations of the I. C.-engine during standard operation and misfire operation as well as protecting the drive from overload. It is a good option both for variable speed and constant speed drives, while a supercritical selection of the drive train above resonance level is always made. Particularly for the series the coupling disk requires smallest possible axial mounting space.

Depending on the type the coupling is pluggable and compensates for displacements resp. tolerances moderately to very well. It is a non-slip or shear type and radially mountable.

The elastomer element is available in various qualities for all types. It is composed of natural rubber compounds optimised over many years (SN, MN, HN, UN up to 80 °C) or upon request of synthetical EPDM material for higher temperatures (SE, ME, HE, UE up to 100 °C). The various kinds of rubber hardness cover one application and torque range per size. The vibratory properties of the four types are compatible within one size.

A wide portfolio of hub connections covers a large variety of shaft configurations on the driven side while special connections can be realised.



SINULASTIC® - The types

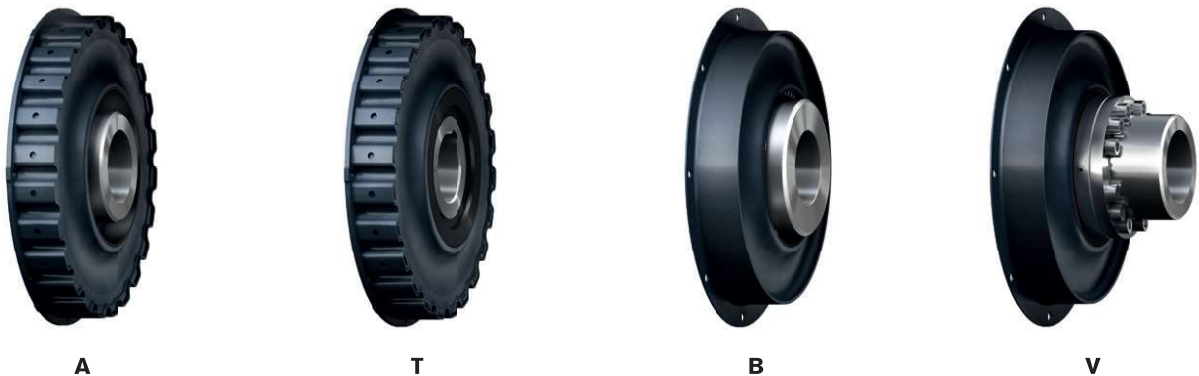

SINULASTIC® A is the evolution design of the renowned disk coupling with plug-in spline between elastomer and flange ring as well as hub vulcanized on. The tooth shape that is subject to high loads particularly with alternating loads in the contact area between motor flange and rubber was extensively optimized, the new sinusoidal tooth shape being eponymous for the series. For the first time the engine flange was realised by a deep-drawn sheet metal section creating a beneficial and smooth surface to the elastomer. Another benefit is the tight contact gap for easy mountability with at the same time highly sound and defined form fit.

In contrast to type A a Taperlock shaft connection as a standard version with feather key is used with SINULASTIC® T. The modular concept makes use of the plug-in ability of type A on the flange side.

Type B and V make use of a deep-drawn and inherently stable flange ring that the elastomer part is vulcanized on externally. This results in a low-cost solution for high speeds and overloads.

In combination with the renowned BoWex® inner hub the SINULASTIC® B as an all-rounder of the overall series is formed. The so-called BoWex® hub defines a pluggable connection resistant to high loads as well as beneficial adaptations on the driven side up to long driving shaft systems owing to the potentials for particularly high displacements. The hub and connection variants of BoWex®-ELASTIC are fully compatible with the elastomer elements of this series.

SINULASTIC® V is used beneficially where the ability for axial plug-in is not required. A resulting radial assembly is realised by a split ring on the hub side.

The slim wasteline shape of the elastomer elements of this type allows for significant displacements in axial, radial and angular direction without any wear, while the coupling element is suitable both for not flange-mounted assembly, i. e. for system configurations set up freely, and as a shaft coupling with cardanic misalignment.

SINULASTIC®

highly flexible couplings

Properties of types compared

Properties of types compared			
Properties	SINULASTIC® A SINULASTIC® T	SINULASTIC® V	SINULASTIC® B
Rated torque T_{KN}	Compatible within the series		
Maximum torque T_{Kmax}	$\geq 2x T_{KN}$	$3x T_{KN}$	$3x T_{KN}$
Vibratory properties, e. g. torsional stiffness	Compatible within the series		
Materials ¹⁾	Natural rubber compounds up to 80 °C for hardness ranges WN, SN, MN and HN, synthetical EPDM up to 100 °C for hardness ranges WE, SE, ME and HE		
Plug-in	Yes	No	Yes
Radial assembly	Partially possible	Yes	No
Mounting length	++	Ø	++
Axial displacement	++	+	++
Radial displacement	Ø	+	+
Angular displacement	Ø	++	++
Standard	For flywheel flange and shaft connection (SAE J620, DIN 5480 et seqq., DIN 6281, etc.)		
Special solutions	Bearing-mounted intermediate coupling, with failure protection, combination with shifting unit	Cardanic offset joint, failure protection, shaft systems	
	Application-specific shaft connections of elastomer elements		

¹⁾The standard materials and availabilities depend on the size and type, special compounds available on request

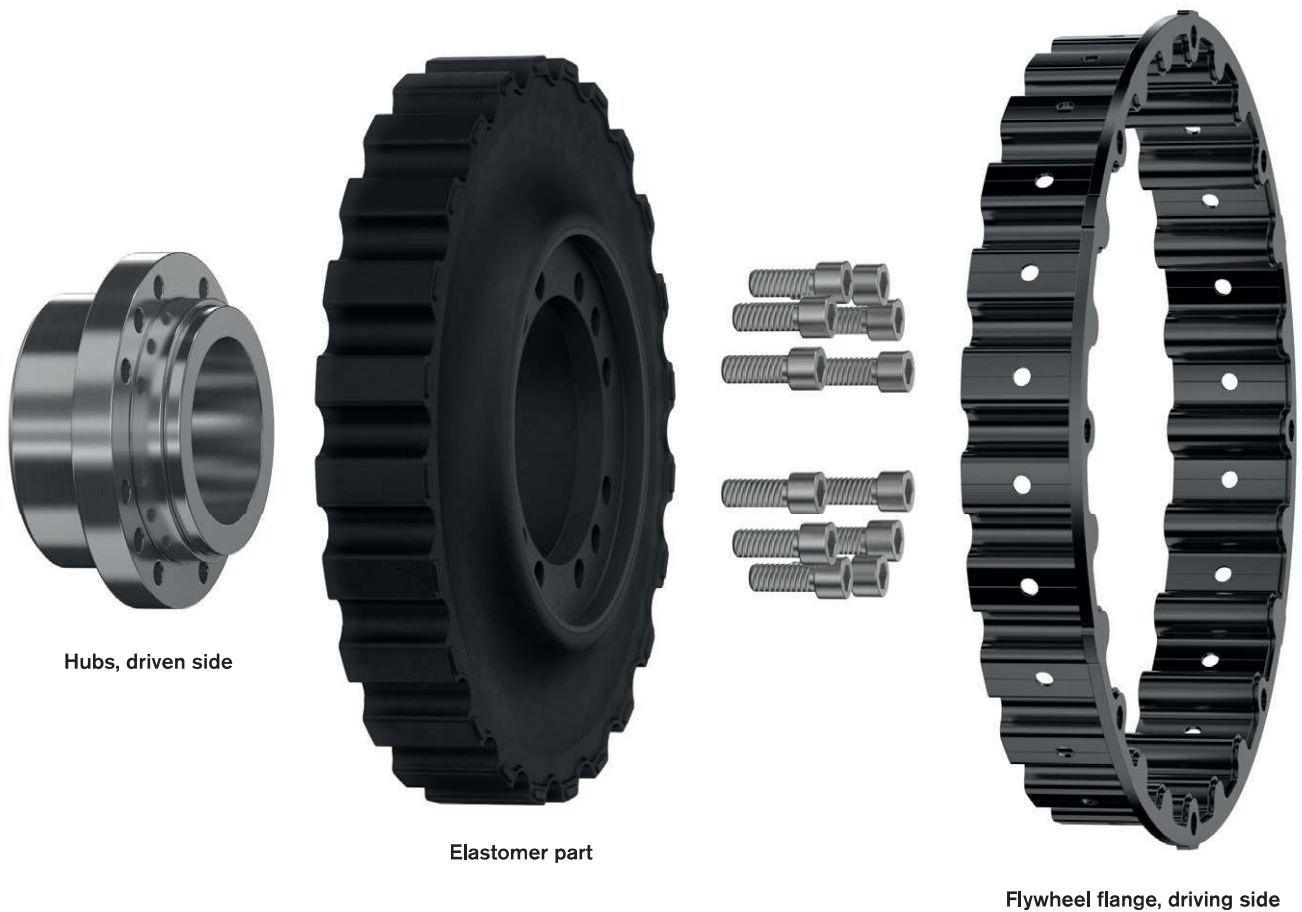

SINULASTIC® B

highly flexible flange coupling

Disk coupling pluggable inside

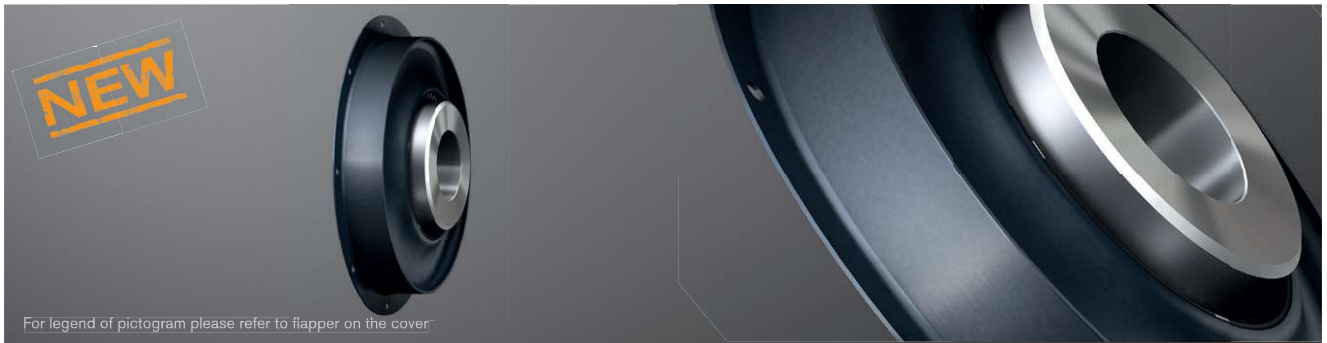

For legend of pictogram please refer to flapper on the cover

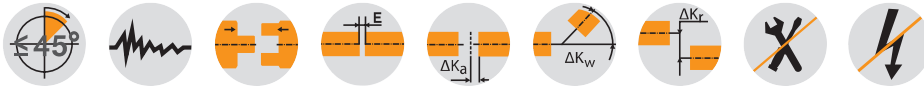

Components

Type B specifies a type pluggable in the hub for variable use and high potential for offset

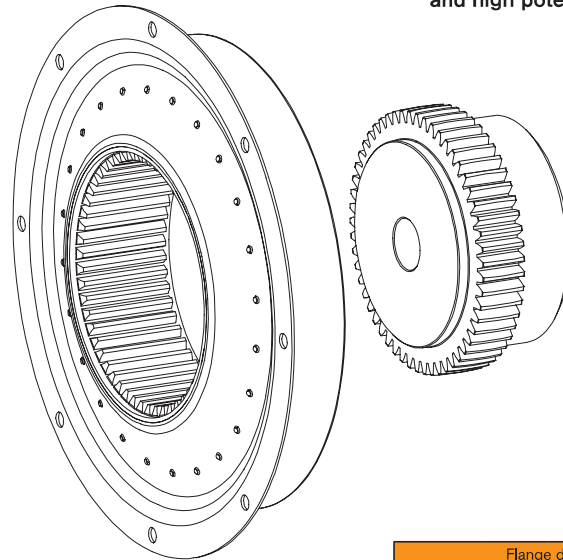
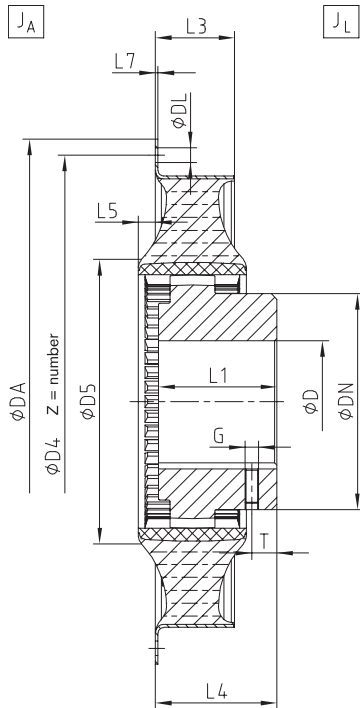

Flange dimensions according to SAE J620 [mm]				
Nominal size	DA	D4	Z	DL
11 1/2"	352.42	333.37	8	11
14"	466.72	438.15	8	13
18"	571.50	542.90	6	17
21"	673.10	641.35	12	17
24"	733.42	692.15	12	21
Ø475	475	450	12	11

Technical data													
Size	Elastomer type	Torque [Nm] ¹⁾				Dynamic torsion spring stiffness C _{dyn} [Nm/rad]		Relative damping ψ [-]		Perm. damping power P _{KW} [W] ²⁾		Operating speed [rpm]	
		T _{KN}	T _{Kmax}	T _{Kmax1}	T _{KW}	30 °C	60 °C	30 °C	60 °C	30 °C	60 °C	n	n _{max}
20	SN	1750	2625	5250	700	7200	5760	1.00	0.80	210	126	3240	3600
	MN	2000	3000	6000	800	11500	9200	1.10	0.90	240	144	3240	3600
	HN	2500	3750	6200	1000	18500	14800	1.30	1.10	270	162	3420	3800
38	SN	3000	4500	9000	1200	14500	11600	1.00	0.80	275	165	2880	3200
	MN	3800	5700	9600	1520	22000	17600	1.10	0.90	300	180	2880	3200
	HN	4600	6900	9600	1840	34000	27200	1.30	1.10	330	198	3240	3600
53	SN	4000	6000	12000	1600	17000	13600	1.00	0.80	285	171	2700	3000
	MN	5300	7950	14400	2120	28000	22400	1.10	0.90	325	195	2700	3000
	HN	6200	9300	14400	2480	43500	34800	1.30	1.10	370	222	3060	3400
140	SN	12000	18000	36000	4800	106000	84800	1.00	0.80	540	324	2160	2400
	MN	14000	21000	42000	5600	149000	119200	1.10	0.90	550	330	2160	2400
	HN	16200	24300	48600	6480	235000	188000	1.30	1.10	570	342	2520	2800
180	SN	14600	21900	43800	5840	192000	105600	1.00	0.80	620	372	2160	2400
	MN	18000	27000	54000	7200	185000	148000	1.10	0.90	630	378	2160	2400
	HN	22000	33000	66000	8800	295000	236000	1.30	1.10	650	390	2340	2600

¹⁾ T_{KN} Torque that can be constantly transmitted over the entire speed range.
T_{Kmax} Transient torque peaks (e. g. resonance passage), min. 100,000 load alternation pulsating / 50,000 load alternation vibratory
T_{Kmax1} Torque loads rarely, min. 1,000 load alternation
For selection consider DIN 740 part II (operating factor, temperature factor), parameters for an ambient temperature of 30 °C.
²⁾ Here permanent damping power. Twice the damping power figure is permissible for one hour.

SINULASTIC® type B

Size	Max. bore D [mm]	Flange connection acc. to SAE - J620						Dimensions [mm]										Mass moment of inertia [kgm ²] ¹⁾		Weight [kg] ¹⁾								
		11 1/2"	14"	18"	21"	24"	Ø475	DN	D5	L1	L3	L4	L5	L7	G	T	J _A	J _L										
20	80	●						124	169	75	60	80,5 ± 21	8,5	2,0	M10	20	0.0625	0.0338	9.71									
			●																									
38	125		●					200	245	140	52	136 ± 14	10	2,5	M16	40	0.1114	0.0338	10.85									
				●																								
							●																					
53	125		●					200	247	140	70.5	143 ± 20	15	2,5	M16	40	0.1524	0.2076	28.94									
				●																								
140	240				●			326	431	200	81	175 ± 12	10	3	-	-	0.1888	0.2280	30.85									
						●																						
180	240				●			326	431	200	101	185 ± 22	10	3	-	-	0.1942	0.2280	32.52									
						●																						
																	0.302	0.2280	30.95									
																	0.8816	1.8812	83.57									
																	1.0708	1.8812	85.10									
																	1.0905	2.0194	88.83									
																	1.2796	2.0194	90.37									

¹⁾ With max. bore

Types of hubs type B ¹⁾

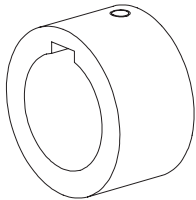

Type 1.0
with feather keyway
and setscrew

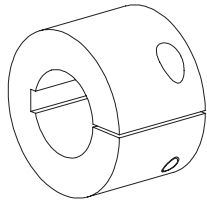

Type 2.1
clamping hub
single slot with
feather keyway

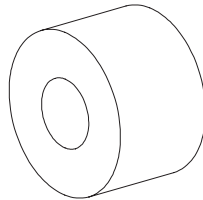

Type 8.0
taper interference fit

Type 8.1
cylindrical
interference fit

¹⁾ Dimensions and type may differ depending on size, other types of hubs on request

Displacements

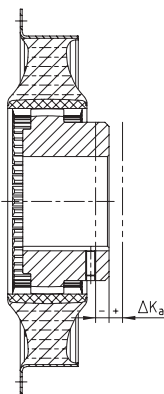

Axial displacement

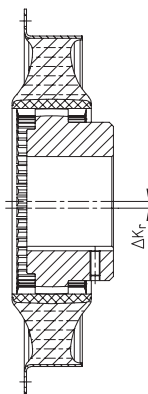

Radial displacement

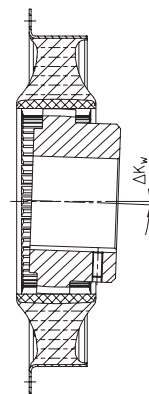

Angular displacement

SINULASTIC® B size		20	38	53	140	180
Perm. axial displacement ΔK_a [mm]		±2	±3.0	±3.0	±4.0	±4.0
Perm. radial displacement ΔK_r [mm]	1500 rpm	0.8	1.1	1.1	1.5	1.5
	n_{max} max. ¹⁾	0.6	0.8	0.8	1.1	1.1
Perm. angular displacement ΔK_w [degree]	1500 rpm	1.0	0.8	0.8	0.6	0.6
	n_{max} max. ¹⁾	0.7	0.6	0.6	0.4	0.4
		2.0	1.6	1.6	1.2	1.2

¹⁾ With assembly for a short time resp. rarely with downtime or start-up operation as well as exceptional load conditions.

Ordering example:	SINULASTIC® 53	B	M	14	1.3	DIN 5480 - 60x2x28
Coupling size	Type	Elastomer hard- ness	Flange ØDA acc. to SAE or special	Hub type	Finish bore	